

ECOLINE 230



Die Branche zeigt deutlich, dass der Höhenzugang mit 3,5 Tonnen immer beliebter wird. Vor allem fordert der Markt moderne Technologien sowie Materialien, die sich in den Premium-Produkten bewährt haben. Diese Marktanforderungen finden sich in der **RUTHMANN**-Entwicklung zur ECOLINE 230 wieder.

Mit dieser LKW-Arbeitsbühne bietet **RUTHMANN** enorme Reichweiten von bis zu 17 m. Kombiniert mit einer Arbeitshöhe von 23 m ist die Bühne ein beliebtes Vermiet- und Vielnutzer-Gerät. Durch die geringeren Anschaffungskosten beweist sich die ECOLINE 230 als Ertragsmaximierer. Bei gleichbleibender Mietrate kann dank der geringeren Anschaffungskosten ein schneller ROI (= return on investment) erreicht werden.

Das Top Preis-Leistungs-Verhältnis zeigt sich vor allem in der bewährten und modernen Technik. Vielkant-Auslegerprofile mit hochfestem Feinkornstahl, **RUTHMANN** Cockpit oder die stabile Turmkonstruktion sind unschlagbare Vorteile, die bisher nur beim Premium Segment **STEIGER®** zu finden waren.

Der Markt kann sich durch und durch auf ein modernes **RUTHMANN** Engineering freuen. Selbstverständlich mit **RUTHMANNSERVICE** und hervorragender After-Sales-Betreuung.



Throughout the industry, there are clear indications that 3.5-ton access equipment is becoming increasingly popular. Customers are particularly interested in premium products with modern technology and materials that have proven themselves over time. **RUTHMANN** focused on these key market demands during the development of the ECOLINE 230.

With this truck-mounted aerial work platform, **RUTHMANN** offers customers an enormous lateral outreach of up to 17 m. Combined with a working height of 23 m, this work platform has become very popular with equipment rental companies and frequent users. The ECOLINE 230 maximizes earnings through the lower acquisition cost, resulting in a higher/faster ROI (= return on investment).

The exceptional price-performance ratio can be attributed to the tried-and-tested modern technology. The multi-beveled boom system, (made of high-strength, fine-grained steel), **RUTHMANN** Cockpit, and sturdy tower construction are unbeatable benefits that had previously only been available on the premium **STEIGER®** models.

The market can look forward to completely new and ultra-modern **RUTHMANN** engineering, along with **RUTHMANNSERVICE** and the excellent after-sales support, of course.

Ihre Vorteile

- TOP Preis-Leistungs-Verhältnis
- Enorme Reichweite von bis zu 17 m
- Hohe Tragfähigkeit: 250 kg Korblast
- Vereinheitlichung des **RUTHMANN** Steuerkonzepts
- 3,5 Tonnen-Chassis (EURO 6), Multi-Chassis fähig
- EASY-Stabilizing System und Secondary Guarding System
- **RUTHMANNSERVICE** ...at its best!

Leistung

Verhältnis

Preis



Your benefits

- top price-performance ratio
- enormous lateral outreach to 17 m
- high loading capacity: 250 kg basket load
- standardization of **RUTHMANN** control concept
- 3,5 t-chassis (EURO 6), multi-chassis compatible
- EASY-Stabilizing System and Secondary Guarding System
- **RUTHMANNSERVICE** ...at its best!

performance





ratio

price









RUTHMANN - Engineering

-  Hochfester Feinkornstahl und Vielkantausleger-Profil
-  RUTHMANN Steuerpult (COCKPIT) nach STEIGER®-Vorbild
-  Bequemer Zugang zum Korb dank Korbtreppe
-  Hochwertige Ausleger- und Turm-Konstruktion







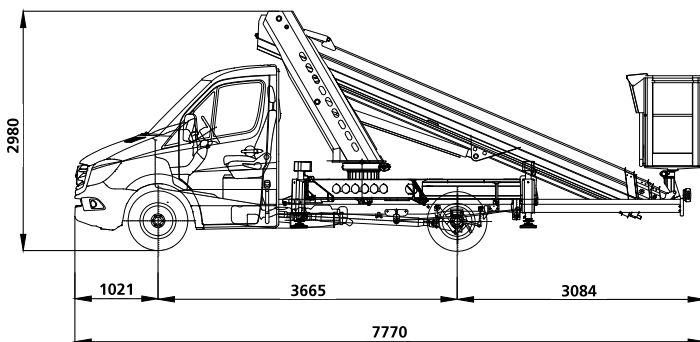

RUTHMANN - Engineering

-  high-strength, fine-grained steel and multi-beveled boom fabrication
-  RUTHMANN control panel (COCKPIT) as on STEIGER® models
-  easy basket access thanks to basket stairs
-  high-quality boom and tower construction



technische Daten | technical data



	23,00 m		±90°		2,98 m
	16,90 m		1,30 m x 0,70 m		7,77 m
	360°		250 kg		3.500 kg

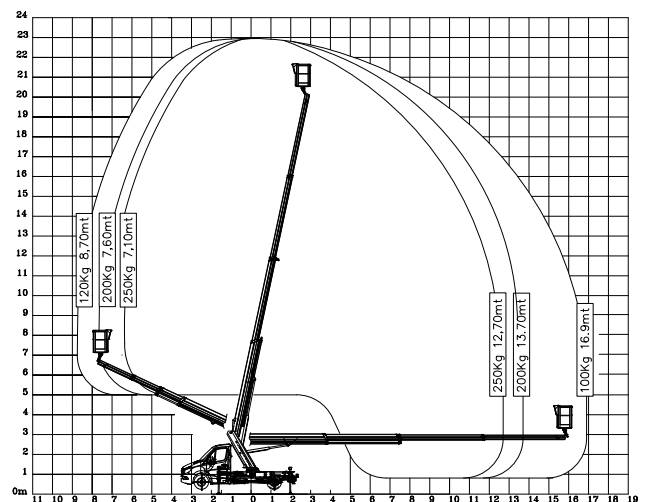

Alle Angaben in Metern. Alle Maße und Gewichte sind ca.-Angaben und beziehen sich auf die serienmäßige Grundausstattung. Technische Änderungen vorbehalten. **Steiger®** und **Rüssel®** sind eingetragene Warenzeichen der **RUTHMANN GmbH & Co. KG**.

Ruthmann GmbH & Co. KG
Von-Braun-Str. 4 - 48712 Gescher-Hochmoor - GERMANY
Fon: +49 2863 204-0 - Fax: +49 2863 204-212
Internet: www.ruthmann.de - E-Mail: vertrieb@ruthmann.de

All measurements and weights are approximate and refer to the standard basic equipment. Technical alterations reserved. **STEIGER®** and **RÜSSEL®** are registered trademarks of **RUTHMANN GmbH & Co. KG**

Ruthmann GmbH & Co. KG
Von-Braun-Str. 4 - 48712 Gescher-Hochmoor - GERMANY
Fon: +49 2863 204-0 - Fax: +49 2863 204-212
Internet: www.ruthmann.de - E-Mail: export@ruthmann.de